

# HFV7A

# AUTOMOTIVE RELAY



### Typical Applications

Fog lamp & headlight control, Rear window defogger, ABS, Fuel pump control, Air-conditioning, Cooling fan control, A/C blower, Horn control, Heating control, Battery disconnection device

### Features

- 50A switching capability
- Extended temp. range up to 125°C
- With transient suppression resistor available
- 1 Form A & 1 Form C contact arrangement
- Plastic sealed and dust protected types available
- RoHS & ELV compliant

## CHARACTERISTICS

Contact arrangement	1A, 1C	Ambient temperature	-40°C to 125°C
Voltage drop (initial)	NO:Typ.20mV,250mV max.(at 10A) NC:Typ.30mV,250mV max.(at 10A)	Vibration resistance <sup>5) 8)</sup>	10Hz to 50Hz 1.0mm DA 50Hz to 500Hz 50m/s <sup>2</sup>
Max. continuous current <sup>1) 8)</sup>	60A (at 23°C); 40A (at 85°C)	Shock resistance <sup>5) 8)</sup>	196m/s <sup>2</sup>
Max. switching current <sup>8)</sup>	50A	Flammability <sup>6)</sup>	UL94-HB or better (meets FMVSS 302)
Max. switching voltage <sup>2)</sup>	50VDC	Termination	QC
Min. contact load	1A 6VDC	Construction	Plastic sealed, Dust protected
Electrical endurance	See "CONTACT DATA"	Unit weight	Approx. 38g
Mechanical endurance	1 x 10 <sup>7</sup> OPS (300OPS/min)	Mechanical data	cover retention (pull & push): 200N min. terminal retention (pull & push): 100N min. terminal resistance to bending (front & side): 10N min. <sup>7)</sup>
Initial insulation resistance	100MΩ (at 500VDC)		
Dielectric strength <sup>3)</sup>	500VAC		
Operate time <sup>8)</sup>	Typ.: 6ms (at nomi. vol.) Max.: 10ms (at nomi. vol.)		
Release time <sup>4) 8)</sup>	Typ.: 4ms Max.: 7ms		

- 1) For NO contacts, measured when applying 100% rated voltage on coil.  
 2) See "Load limit curve" for details.  
 3) 1min, leakage current less than 1mA.  
 4) The value is measured when voltage drops suddenly from nominal voltage to 0 VDC and coil is not paralleled with suppression circuit.  
 5) When energized, opening time of NO contacts shall not exceed 100μs, when non-energized, opening time of NC contacts shall not exceed 100μs, meantime, NO contacts shall not be closed.  
 6) FMVSS: Federal Motor Vehicle Safety Standard.  
 7) Test point is at 2mm away from terminal end, and after removing testing force, the terminal transfiguration shall not exceed 0.5mm.  
 8) Only for the 12VDC coil voltage type.

## CONTACT DATA <sup>4)</sup>

Load voltage	Load type		Load current A			On/Off ratio		Electrical endurance OPS	Contact material	Load wiring diagram <sup>3)</sup>	Ambient temp.
			1C		1A	On s	Off s				
			NO	NC	NO						
13.5 VDC	Resistive	Make	50	30	50	2	2	1×10 <sup>5</sup>	AgSnO <sub>2</sub>	See diagram 1	at 23°C
		Break	50	30	50						
	Inductive	Make <sup>1)</sup>	150	---	150	2	4	1×10 <sup>5</sup>	AgSnO <sub>2</sub>	See diagram 2	See Ambient temp. curve
		Break	35	---	35						
	Lamp <sup>2)</sup>	Make	150	---	150	0.5	10	1×10 <sup>5</sup>	AgSnO <sub>2</sub>	See diagram 3	
		Break	30	---	30						



HONGFA RELAY  
 ISO9001, ISO/TS16949, ISO14001, OHSAS18001, IECQ QC 080000 CERTIFIED

2012 Rev. 1.01

- 1) Corresponds to the peak inrush current on initial actuation.
- 2) The load in the table excludes flasher. When applied in flasher, a special silver alloy (AgSnO<sub>2</sub>) contact material should be used and the customer special code should be (170) as a suffix. Please heed the anode and cathode's request when wired, terminal 30 should connect with anode.
- 3) The load wiring diagrams are listed below:

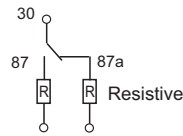

diagram 1

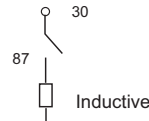

diagram 2

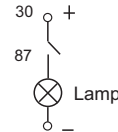

diagram 3

- 4) Loads mentioned in this chart is for relays with no parallel diode or Zener Diode. For those with parallel diode, Zener Diode or other components, please contact Hongfa for more technical supports.  
Please also contact Hongfa if the actual application load is different from what mentioned above.

## COIL DATA

at 23°C

	Nominal voltage VDC	Pick-up voltage VDC max.	Drop-out voltage VDC min.	Coil resistance $\times(1\pm 10\%)\Omega$	Parallel resistance $\times(1\pm 5\%)\Omega$	Equivalent resistance $\Omega$	Power consumption W	Max. allowable overdrive voltage <sup>1)</sup> VDC	
								at 23°C	at 85°C
Standard	6	3.6	0.6	22.5	---	--	1.6	10	9
	6	3.6	0.6	22.5	180	20	1.8	9	9
	12	7.2	1.2	90	---	---	1.6	21	18
	12	7.2	1.2	90	680	79.5	1.8	18	18
	24	14.4	2.4	360	---	---	1.6	43	34
	24	14.4	2.4	360	2700	317.6	1.8	36	34
High power consumption	6	3.6	0.6	18	---	--	2.0	9	7
	6	3.6	0.6	18	180	16.4	2.2	9	7
	12	7.2	1.2	72	---	---	2.0	19	14
	12	7.2	1.2	72	680	65.1	2.2	18	14
	24	14.4	2.4	288	---	---	2.0	39	28
	24	14.4	2.4	288	2700	260.2	2.2	36	28

1) Max. allowable overdrive voltage is stated with no load applied.

## ORDERING INFORMATION

Type	HFV7A /	012	-H	4	S	P	T	-R	(XXX)
Coil voltage	006: 6VDC 012: 12VDC 024: 24VDC								
Contact arrangement	H: 1 Form A Z: 1 Form C								
Version	4: Plastic Bracket 6: Metal Bracket Nil: No Bracket								
Construction <sup>1)</sup>	S: Plastic sealed <sup>2)</sup> Nil: Dust protected								
Coil power	P: High power consumption Nil: Standard								
Contact material	T: AgSnO <sub>2</sub>								
Parallel coil <sup>3)</sup> components	R: Parallel transient suppression resistors D: Parallel transient suppression diode, with anode connected to terminal#85 D1: Parallel transient suppression diode, with anode connected to terminal#86 Nil: Without parallel components								
Customer special code									

1) Dust protected version is recommended.

2) If washing or surface treatment is required after the relay is assembled on PCB, please provide with the conditions in details for our confirmation or our recommendation with suitable products.

3) If parallel diode, Zener Diode or other components are required, please contact Hongfa for more technical supports.

# OUTLINE DIMENSIONS AND WIRING DIAGRAM

Unit: mm

## Outline Dimensions

HFV7A/□□□-H□□□-□(XXX)

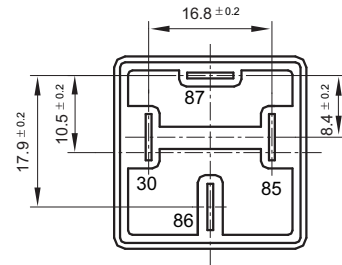
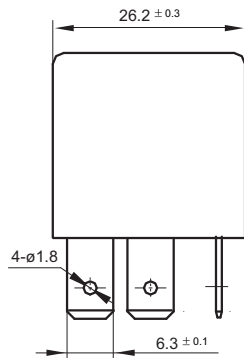
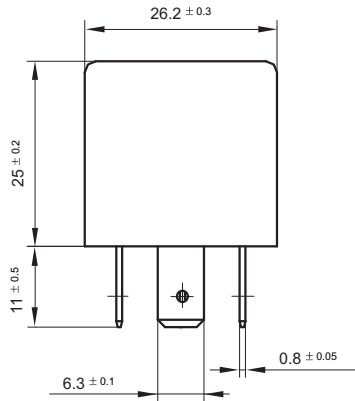

(Bottom view)

HFV7A/□□□-Z□□□-□(XXX)

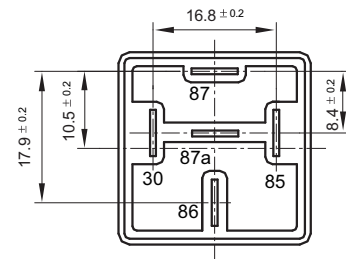
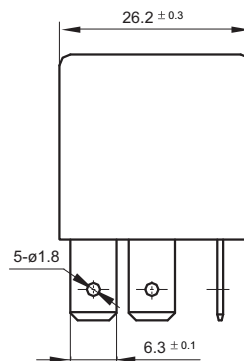
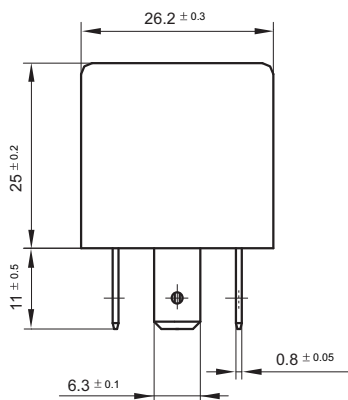

(Bottom view)

HFV7A/□□□-Z4□□□-□(XXX)

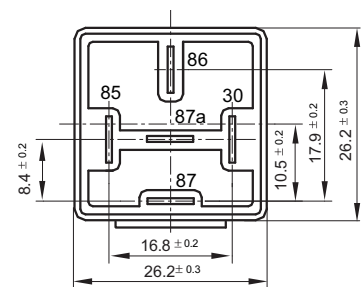
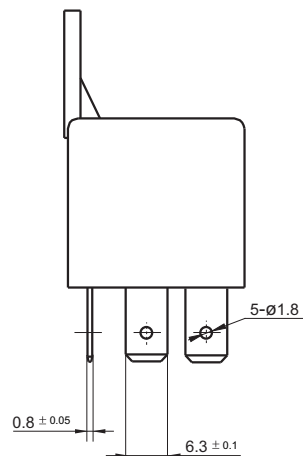
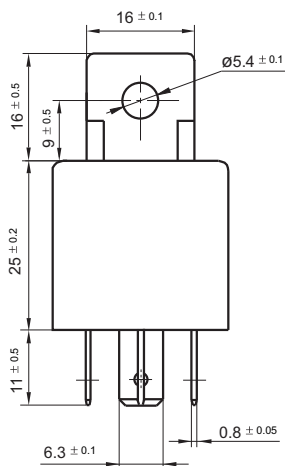

(Bottom view)

# OUTLINE DIMENSIONS AND WIRING DIAGRAM

Unit: mm

## Outline Dimensions

HFV7A/□□□-Z6□□□-□(XXX)

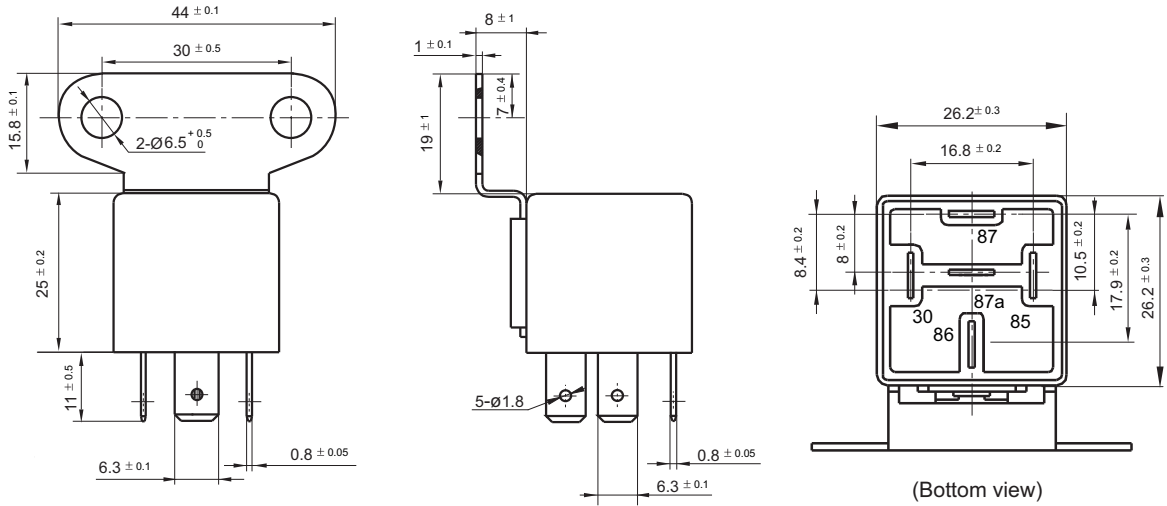

Remark: Terminal vertical deviation tolerance is 0.3mm.

## Wiring Diagram

HFV7A/□□□-H□□□□(XXX)

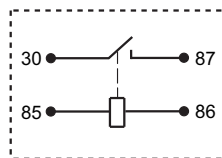

HFV7A/□□□-Z□□□□(XXX)

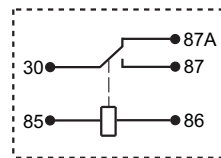

HFV7A/□□□-H□□□□-R(XXX)

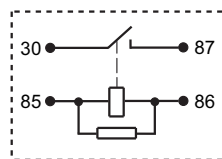

HFV7A/□□□-Z□□□□-R(XXX)

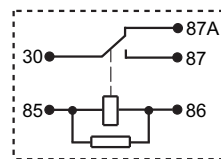

HFV7A/□□□-H□□□□-D(XXX)

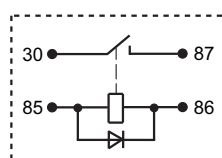

HFV7A/□□□-Z□□□□-D(XXX)

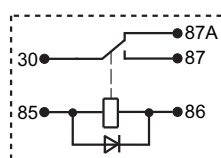

HFV7A/□□□-H□□□□-D1(XXX)

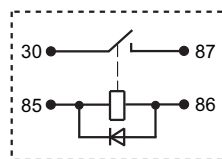

HFV7A/□□□-Z□□□□-D1(XXX)

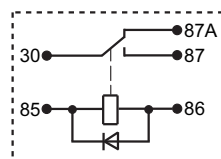

## CHARACTERISTIC CURVES

### 1. Coil operating voltage range

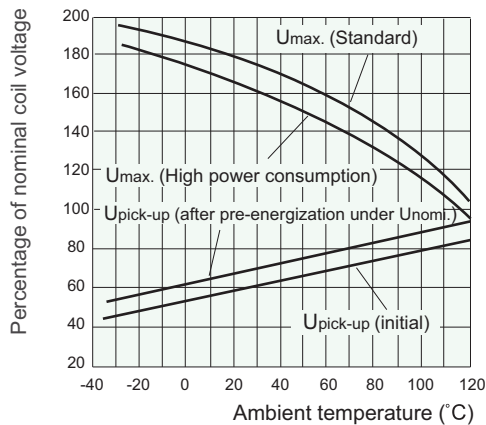

- 1) There should be no contact load applied when maximum continuous operation voltage is applied on coil.
- 2) The operating voltage is connected with coil energized time and voltage. After energized, the operating voltage will increase.
- 3) The maximum allowable coil temperature is 180°C. For the coil temperature rise which is measured by resistance is average value, we recommend the coil temperature should be below 170°C under the different application ambient, different coil voltage and different load etc.
- 4) If the actual operating coil voltage is out of the specified range, please contact Hongfa for further details.

### 2. Load limit curve

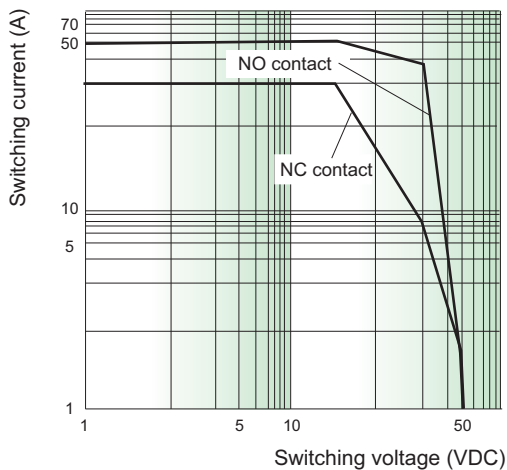

- 1) The contact load is resistive.
- 2) The load and electrical endurance tests are made according to "CONTACT DATA" parameters' table. If actual load voltage, current, or operate frequency is different from "CONTACT DATA" table, please arrange corresponding tests for confirmation.

### 3. Ambient temperature curve of the electrical endurance test

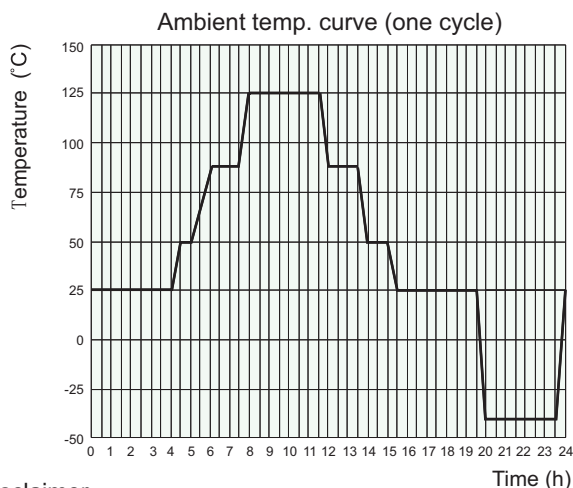

- 1) The minimum temperature is -40°C.
- 2) The maximum temperature is 125°C.

#### Disclaimer

This datasheet is for the customers' reference. All the specifications are subject to change without notice. Before referring to this datasheet, please make sure that you have read and understood "Explanation to Terminology and Guidelines of Automotive Relay & Module" in our catalogue of Automotive Relay & Module.

In case there is specific criterion (such as mission profile, technical specification, PPAP etc.) checked and agreed by and between customer and Hongfa, this specific criterion should be taken as standard regarding any requirement on Hongfa product.

We could not evaluate all the performance and all the parameters for every possible application. Thus the user should be in a right position to choose the suitable product for their own application. If there is any query, please contact Hongfa for the technical service. However, it is the user's responsibility to determine which product should be used only.

© Xiamen Hongfa Electroacoustic Co., Ltd. All rights of Hongfa are reserved.