

慈溪市万捷电子有限公司

CIXI WANJIE ELECTRONIC CO., LTD

产品规格书
THE SPEC SHEET

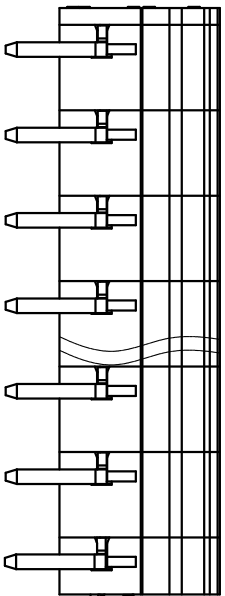
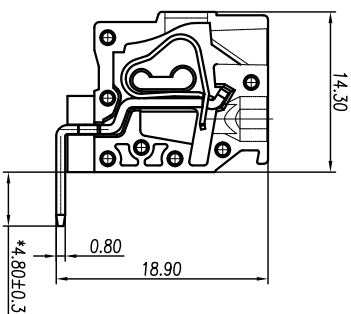
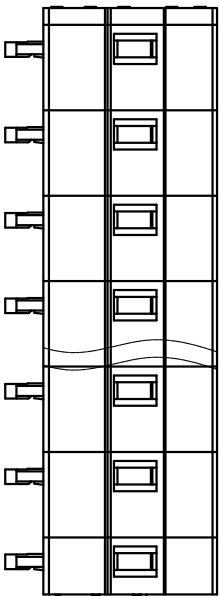
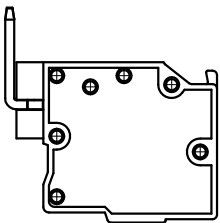
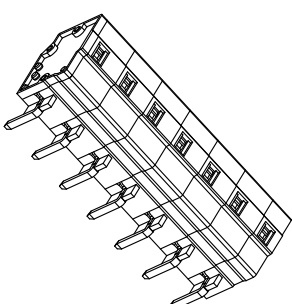
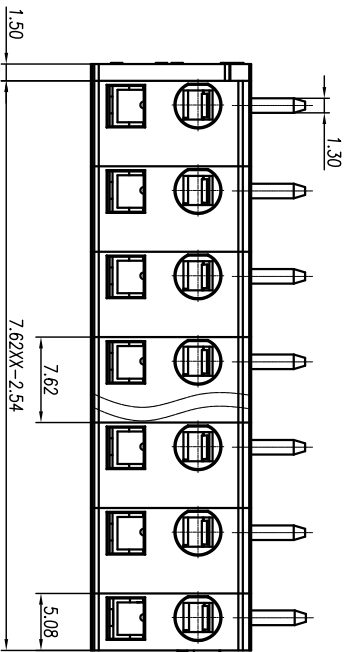

参考标准/Standard

额定电压/Rated voltage

UL 300V
IEC 250V

额定电流/Rated current

15A 16A

接触电阻/Contact resistance

20mΩ 16A

绝缘电阻/Insulation resistance

500MΩ/DC500V

使用线径/Wire range

28-12AWG 2.5mm²

耐电压/With standing voltage

AC 2000V/1 Min

机械性能/Mechanical

8.9mm

剥线长度/Strip Length

-40°C~+105°C

温度范围/Temp. Range

尺寸/Dimensions

间距/Pitch

7.62mm

极数/Poles

2-24p

材质及电镀/Material

PA66, UL94V-0

塑件/Housing

Stainless steel

弹片/Wire guard

Red copper, Tin plated

导电针/Conductor

linear dimension(Tolerances Standard GB/T 14486-2008)

tolerance	±0.1	±0.14	±0.19	±0.25	±0.32	±0.43	±0.57	±0.72	±0.88	±1.05	±1.25	0.5	0.025	0.06	0.12	0.4							
variable range	6 to	6 to	10 to	10 to	18 to	30 to	30 to	50 to	50 to	80 to	80 to	120 to	120 to	160 to	160 to	200 to	250 to	250 to	5 to	5 to	30 to	30 to	120 to
tolerance	±0.1	±0.14	±0.19	±0.25	±0.32	±0.43	±0.57	±0.72	±0.88	±1.05	±1.25	0.5	0.025	0.06	0.12	0.4							

第三视图 THIRD ANGLE PROJECTION

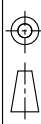

单位/UNITS	mm	尺寸/SIZE	A4	比例/SCALE	1:5.1
慈溪市万捷电子有限公司 CIXI WANJIE ELECTRONIC CO., LTD					

名称/TITLE	WJ0704-02XX-1YY-00A
----------	---------------------