

HFE9

MINIATURE HIGH POWER LATCHING RELAY



File No.:E133481



File No.:CQC07017019644



Features

- Latching relay
- 60A switching capability
- The relay can stand 1440A peak current for 10ms
- 4kV dielectric strength(between coil and contacts)
- Heavy load up to 15000VA
- Environmental friendly product (RoHS compliant)
- Outline Dimensions: (38.0 x 30.0 x 16.0) mm

CONTACT DATA

Contact arrangement	1A, 1B		
Contact resistance	1mΩ max.(at 1A 24VDC)		
Contact material	AgSnO ₂		
Contact rating (Res. load)	60A 250VAC	50A 250VAC	40A 250VAC
	5000OPS	10000OPS	100000OPS
Max. switching voltage	250VAC		
Max. switching current	60A		
Max. switching power	15000VA		
Mechanical endurance	1 x 10 ⁶ OPS		
	Meter: 1 x 10 ⁵ OPS		
Electrical endurance	1 x 10 ⁵ OPS (at 40A 250VAC)		

CHARACTERISTICS

Insulation resistance	1000MΩ (at 500VDC)	
Dielectric strength	Between coil & contacts	4000VAC 1min
	Between open contacts	1500VAC 1min
Creepage distance	8mm	
Operate time (at nomi. volt.)	20ms max.	
Release time (at nomi. volt.)	20ms max.	
Shock resistance	Functional	98m/s ²
	Destructive	980m/s ²
Vibration resistance	10Hz to 55Hz 1.5mm DA	
Humidity	5% to 85% RH	
Ambient temperature	-40°C to 70°C	
Termination	QC	
Unit weight	Approx. 33g	
Construction	Plastic sealed, Flux proofed	

Notes: The data shown above are initial values.

COIL

Coil power	Single coil latching: Approx. 1.0W
	Double coils latching: Approx. 2.0W

COIL DATA

at 23°C

Nominal Voltage VDC	Set / Reset Voltage VDC max.	Pulse width (ms) min.		Coil Resistance x (1±10%) Ω
5	3.5	50		Single coil latching
6	4.2	50	35	
9	6.3	50	80	
12	8.4	50	145	
24	16.8	50	575	
48	33.6	50	2270	
5	3.5	50	Double coils latching	12+12
6	4.2	50		17.5+17.5
9	6.3	50		40+40
12	8.4	50		72+72
24	16.8	50		285+285
48	33.6	50		1135+1135

Notes: When requiring other nominal voltage, special order allowed.

SAFETY APPROVAL RATINGS

UL/CUL	40A 250VAC at 70°C
	50A 250VAC at 70°C
	60A 250VAC at 70°C

Notes: Only some typical ratings are listed above. If more details are required, please contact us.



HONGFA RELAY

ISO9001, ISO/TS16949, ISO14001, OHSAS18001, IECQ QC 080000 CERTIFIED

2013 Rev. 1.00

ORDERING INFORMATION

Type	HFE9	-3 /	12	-D	S	T	-R (XXX)
Version	1: 1 type (Single coil latching) 2: 2 type (Single coil latching) 3: 3 type (Double coils latching)						
Coil voltage	5, 6, 9, 12, 24, 48VDC						
Contact form ¹⁾	D: 1 Form B(No UL,CQC approval) H: 1 Form A						
Construction ²⁾	S: Plastic sealed			Nil: Flux proofed			
Contact material	T: AgSnO ₂						
Polarity	R: Negative polarity			Nil: Positive polarity			

Customer special code

- Notes: 1) H means that relay is on the "reset" status when delivery; D means that relay is on the "set" status when delivery. If no special required by customer, we will keep the relay on the "set" status when delivery.
 2) If water cleaning is required after the relay is assembled on PCB, please contact us for suggestion about suitable parts.
 3) We can make special design according to customer's requirement. Please see the typical design.

OUTLINE DIMENSIONS, WIRING DIAGRAM AND PC BOARD LAYOUT

Unit: mm

Outline Dimensions

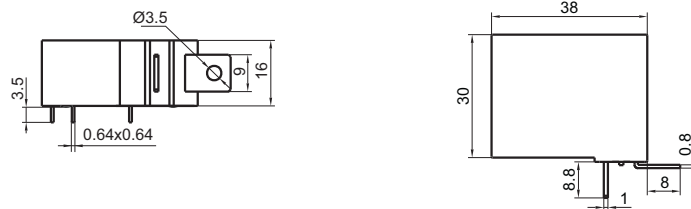

PCB Layout (Bottom view)

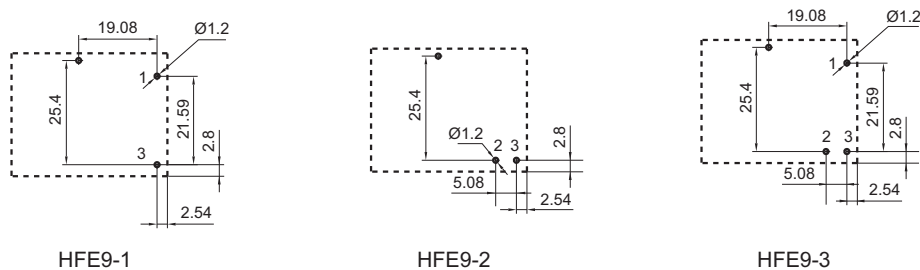

- Remark: 1) In case of no tolerance shown in outline dimension: outline dimension $\leq 1\text{mm}$, tolerance should be $\pm 0.2\text{mm}$; outline dimension $> 1\text{mm}$ and $\leq 5\text{mm}$, tolerance should be $\pm 0.3\text{mm}$; outline dimension $> 5\text{mm}$, tolerance should be $\pm 0.4\text{mm}$.
 2) The tolerance without indicating for PCB layout is always $\pm 0.1\text{mm}$.

Wiring Diagram (Bottom view)

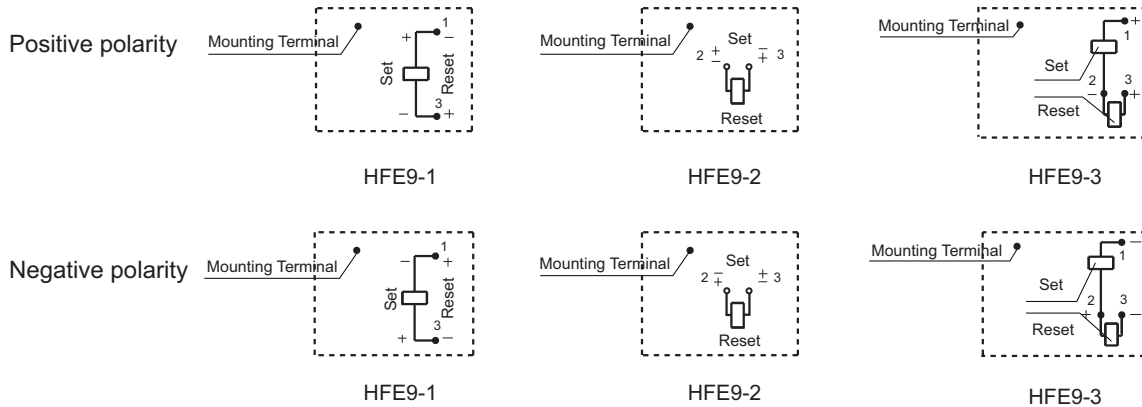

Typical Design

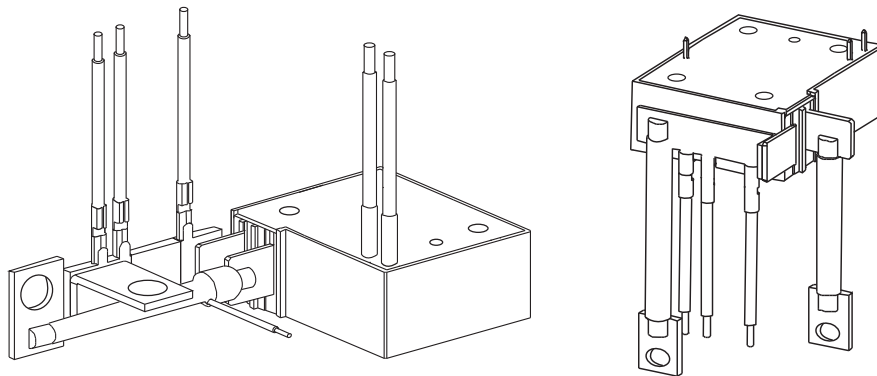

Notes: The drawing shown above are typical design, we can make special design according to customer's requirement. Please provide us with the drawing.

Notice

1. When choose the relay with PCB termination, the recommended welding temperature range and duration is 240°C~260°C, 2s~5s; Please do not use the reflow welding method, if the reflow is really required, please contact our technicals; the normal recommended wave soldering temperature is 250°C within 2s.
2. Relay is on the "reset" or "set" status when being released from stock, with the consideration of shock risen from transit and relay mounting, relay would be changed to "set" or "reset" status, therefore, when application (connecting the power supply), please reset the relay to "set" or "reset" status on request.
3. In order to maintain "set" or "reset" status, energized voltage to coil should reach the rated voltage, impulse width should be 5 times more than "set" or "reset" time. Do not energize voltage to "set" coil and "reset" coil simultaneously. And also long energized time (more than 1 min) should be avoided.
4. The terminals of relay without twisted copper wire can not be tin-soldered, can not be moved willfully.
5. Relays used for metering measuring applications are usually made with dust proof structure, while most relays could be made specially per customer's specific requirements. No longer than 6 months' storage time is recommended for this kind of relay, and please pay attention to the storage environment. To ensure contact reliability, we will keep contact status be closed when delivery if no special required by customer.

Disclaimer

This datasheet is for the customers' reference. All the specifications are subject to change without notice. We could not evaluate all the performance and all the parameters for every possible application. Thus the user should be in a right position to choose the suitable product for their own application. If there is any query, please contact Hongfa for the technical service. However, it is the user's responsibility to determine which product should be used only.